

**QUALITY FEATURES FOR BETTER PICTURES,
EASIER OPERATION, LONGER LIFE**

- Completely automatic operation...
Flip the switch and built-in adjustable limit switches control up and down travel.
- Stops in intermediate positions...
for wide screen projection.
- Easily installed...
Fastens to wall or ceiling with two screws or hooks. Cord plugs into standard outlet (110-120AC or 220-240AC based on model ordered).
- Always ready for the show...
No storage problems. Attractive slimline metal case makes a handsome addition to any room.
- Incomparable picture reproduction...
with Da-Lite's glass beaded or non-gloss Matte White surface.
- Ideal projection screen...
for family centers, recreation rooms, dens, clubs, church rooms, offices, classrooms, small conference rooms.

**DA-LITE IS MORE
THAN PROJECTION SCREENS**

Da-Lite Tripod, Wall and Ceiling and Electric Screens

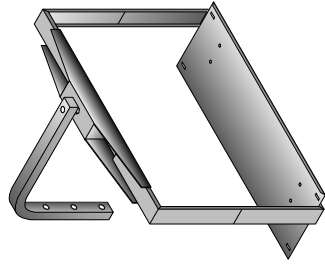
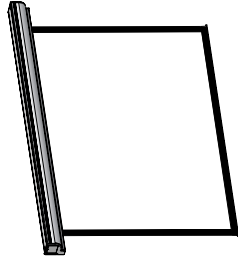

Da-Lite Monitor Mounts



Da-Lite Lecterns

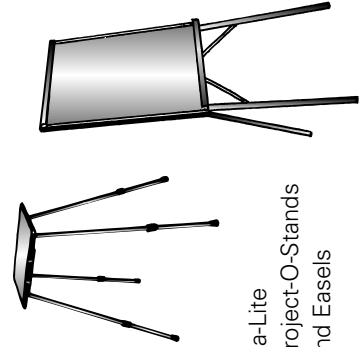

Da-Lite Project-O-Stands and Easels

The POWER In PRESENTATION PRODUCTS



DA-LITE SCREEN COMPANY, INC.

3100 North Detroit Street
Post Office Box 137
Warsaw, Indiana 46581-0137
Phone: 574/267-8101
800-622-3737
Fax: 574/267-7804
www.da-lite.com
e-mail: info@da-lite.com

Operating Instructions

for

SLIMLINE ELECTROL®

IMPORTANT SAFETY INSTRUCTIONS

When using your video equipment, basic safety precautions should always be followed, including the following:

1. Read and understand all instructions before using.
2. Position the cord so that it will not be tripped over, pulled, or contact hot surfaces.
3. If an extension cord is necessary, a cord with a current rating at least equal to that of the appliance should be used. Cords rated for less amperage than the appliance may overheat.
4. To reduce the risk of electric shock, do not disassemble this appliance. Contact an authorized service dealer when repair work is required. Incorrect reassembly can cause electric shock when the appliance is used subsequently.
5. The use of an accessory attachment not recommended by the manufacturer may cause a risk of fire, electric shock, or injury to persons.

SAVE THESE INSTRUCTIONS

3-POSITION SWITCH FOR SLIMLINE

Complete with cable, is standard with the Slimline Electrol.

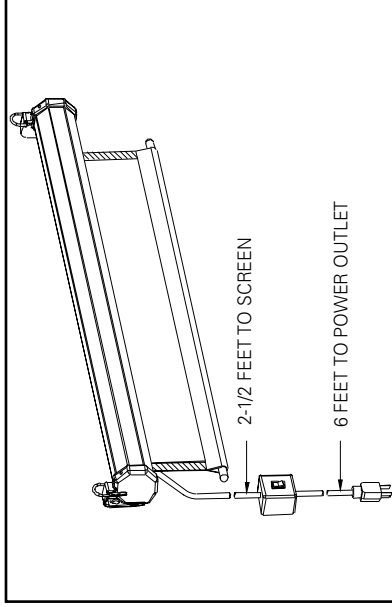

SUGGESTED METHODS OF INSTALLATION

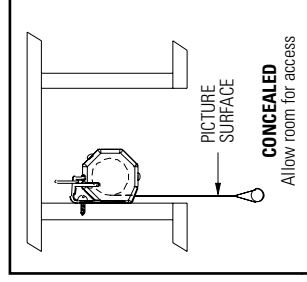
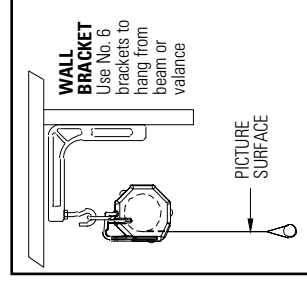
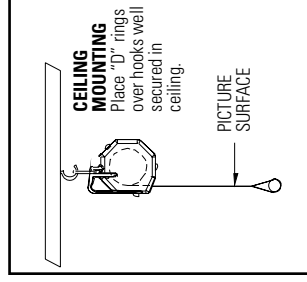
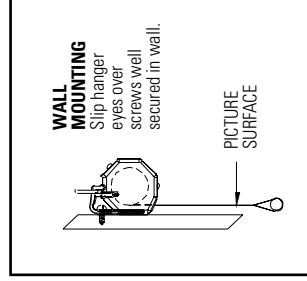

OPERATING INSTRUCTIONS

TO LOWER SCREEN SURFACE

Press lower end of slide switch. Screen will stop in the "DOWN" position automatically.

TO RAISE SCREEN SURFACE

Press upper end of slide switch. Screen will stop in the "UP" position automatically.

TO STOP SCREEN

Screen may be stopped in any intermediate position by positioning slide switch to center "OFF" position.

NOTE: It is suggested that when screen is not in use, the slide switch should be positioned to center "OFF" position.

CARE OF SCREENS

1. Examine surface to be sure it is free of insects, dirt or foreign matter before rolling into case.
2. Screen may be operated as frequently as necessary but should not be run up and down continuously. To do so will cause the motor to overheat and the thermal overload to cut out. Should this occur, it will be necessary to wait for the motor to cool sufficiently to resume operation.
3. Motor does not require lubrication.

HANGING BRACKETS (Optional at extra cost)



NO. 6 WALL BRACKET

No. 6 WALL BRACKET
Non-adjustable permits screen to extend 6" from wall.

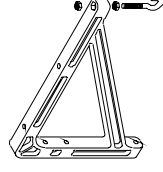

NO. 11 WALL BRACKET

No. 11 WALL BRACKET
Non-adjustable permits screen to extend 10" or 14" from wall.